

HUMMER BIOS

8" LCD SCREEN MID TOWER

USER MANUAL

■ Chassis disassembly

Open the front panel from the front bottom. Open the left side from the front left and right side panel from the back.

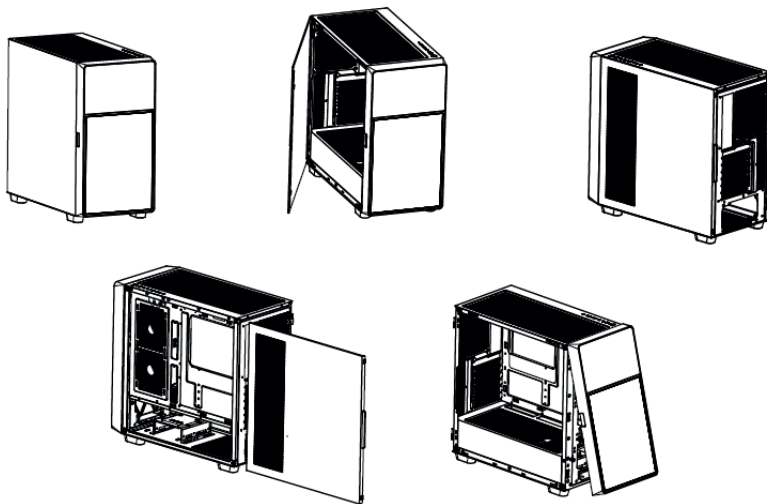

■ Fans or liquid cooler installation

Place the fans or liquid cooler into the desired location and fix them with screws.

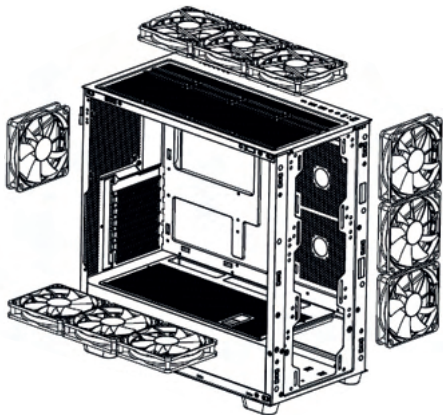

TOP: Support 3*120 mm / 2*140 mm
Support 240/280/360 mm Liquid cooler

FRONT: Support 3*120 mm / 3*140 mm
Support 240/280/360 mm Liquid cooler

BOTTOM: Support 3*120 mm

REAR: Support 1*120 mm / 1*140 mm
Support 120 mm Liquid cooler

■ Installation of PSU

Place the power supply into the PSU chamber and fix it with the PSU screws as shown.

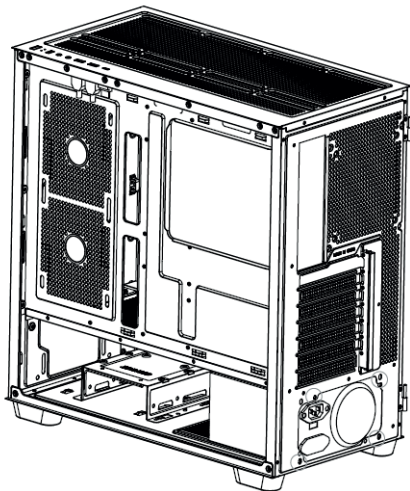

■ 3.5" HDD and 2.5" SSD Installation

2.5" SSD installation

Unscrew and remove HDD bracket, insert a 2.5" SSD and then fix it with screws.

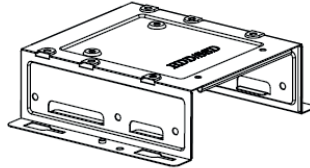
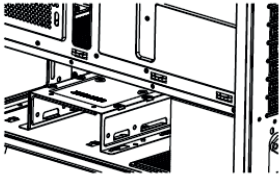

3.5" HDD installation

Unscrew and remove HDD bracket, insert the 3.5" HDD into the bracket and then fix it with screws at both sides, then place and screw the bracket again into the chassis.

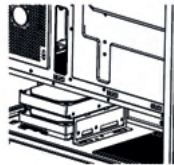
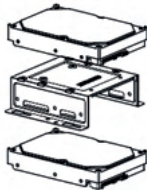
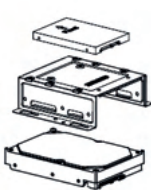

■ Motherboard installation

Fit the I/O plate into the slot, place the motherboard in its location and then fix it with screws.

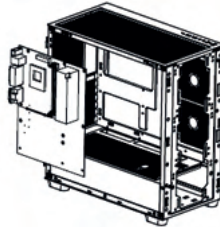
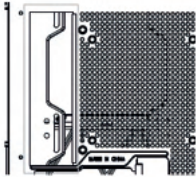

■ VGA installation

Remove the PCI card slot, place the VGA card into your motherboard PCI slot and the chassis card slot, then fix it with screws.

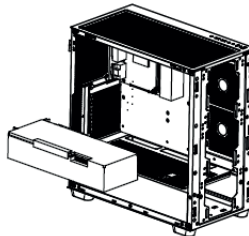
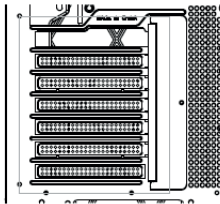

■ USB 3.0 installation

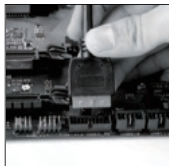



Plug in the USB 3.0 connector to the motherboard.

■ Audio HD installation

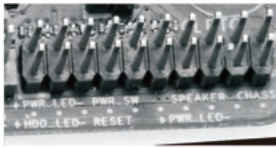

Plug in the AUDIO HD connector to the motherboard.

■ Motherboard connections

	Plug in the HDD LED connector to the motherboard as marked	
	Plug in the POWER LED connector to the motherboard as marked	
	Plug in the POWER SW connector to the motherboard as marked	

Please be careful and always connect + to + and - to -

■ LCD Screen Specification

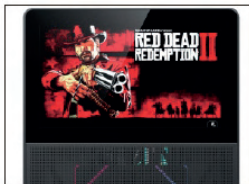

Screen size: 8" TFT-LCD
Color depth: 16.7 million
Resolution: 1280x800 px
Aspect ratio: 16:10

■ LCD Installation



STEP 1:
Please make sure
the motherboard
has USB interface.



STEP 2:
On front panel
have USB Type- C connector
& USB connector cable.



STEP 3:
Connect the USB connector
from front panel to USB interface
on motherboard.

■ **Software download and installation**

Please go to our website www.nox-xtreme.com, search for the product you are looking for and download the software.

Start the installation and follow all the step until the installation has been finished.
Open the App and start the customization of the LCD panel.

■ **APP extended user manual**

Please go to our website www.nox-xtreme.com, search for the product you are looking for and download the extended version of the user manual.

www.nox-xtreme.com

nox

www.nox-xtreme.com